

A DETAIL

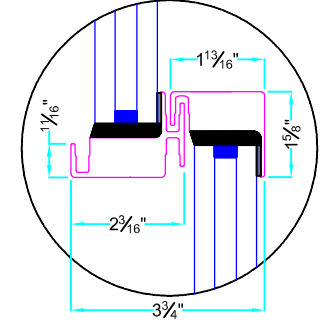

B DETAIL

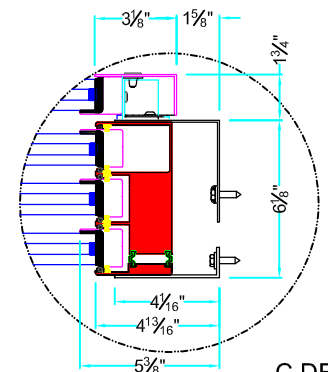

C DETAIL

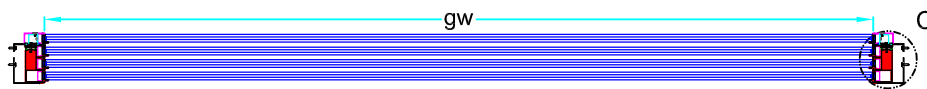

Specifications, designs, technical information, prices or similar intellectual property contained in these drawings are the exclusive property of Libart. This information, whole or part cannot be used, copied, shared or reproduced without written permission from Libart.



LIBART
MOTION IN ARCHITECTURE

T. +90 212 879 02 65 LIBART.COM

PROJECT REFERENCE	GUD-W4	DWG	01	REV	03	CUSTOMER
TITLE	PLAN-SECTION-FRONT VIEW	DATE	28.12.2016		PROJECT NAME	GU-W4-SYSTEM CLOSED	
DRAWING BY	GULTEKIN YILMAZ				CONFIRMED BY		
CONTROLLED BY	ERDAL SAYAR				CONFIRMATION DATE		

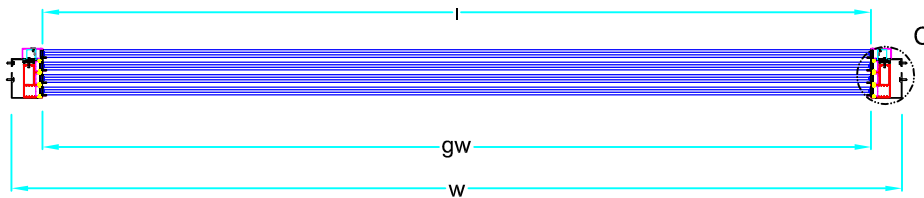
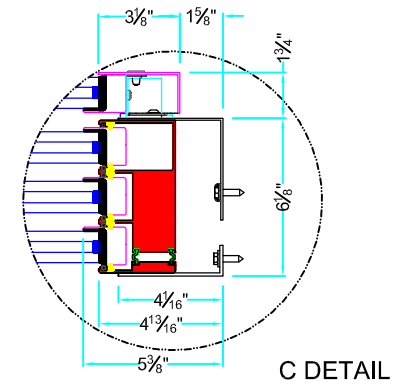
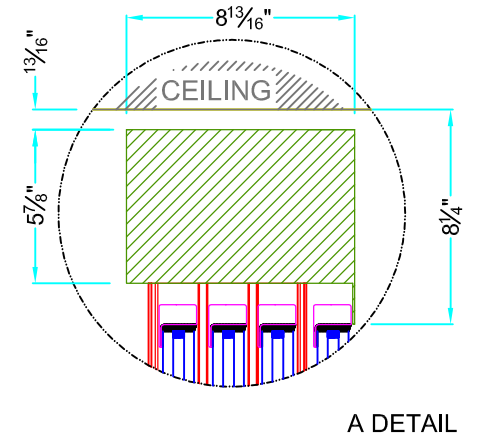
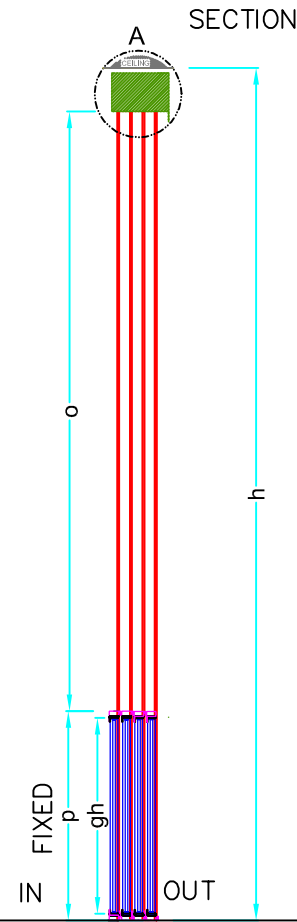
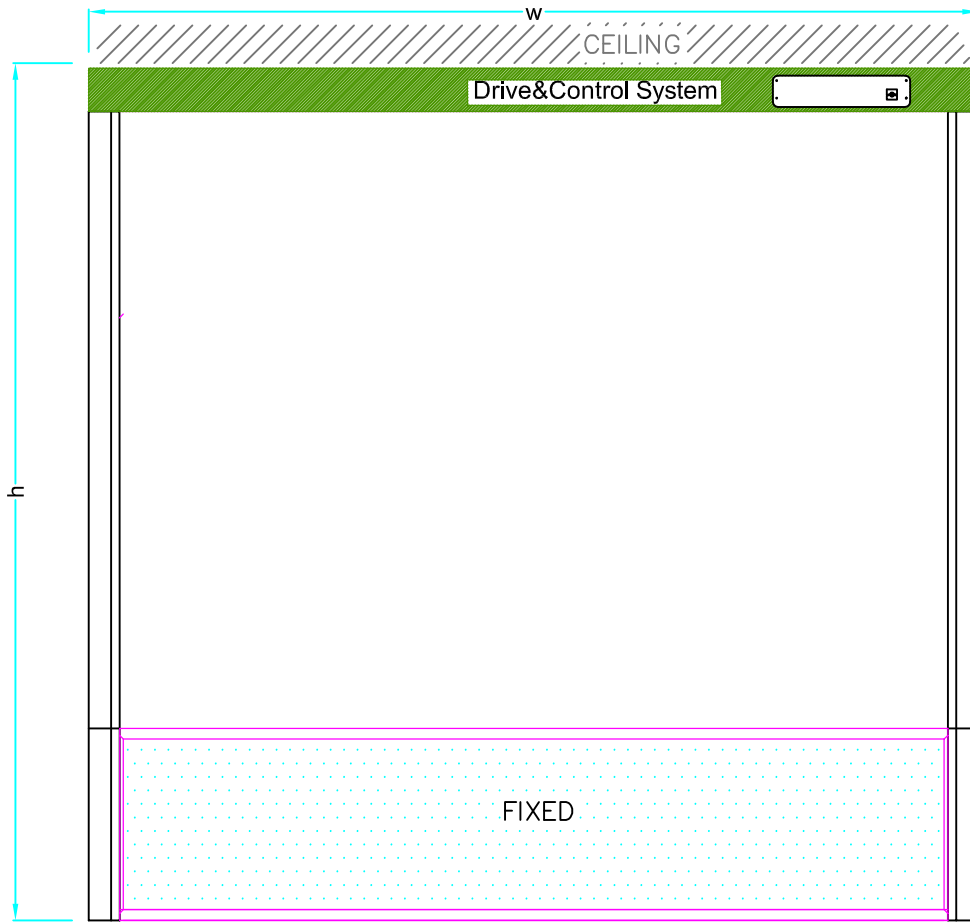

Specifications, designs, technical information, prices or similar intellectual property contained in these drawings are the exclusive property of Libart. This information, whole or part cannot be used, copied, shared or reproduced without written permission from Libart.



PROJECT REFERENCE	GUD-W4	DWG	02	REV	03	CUSTOMER
TITLE	PLAN-SECTION-FRONT VIEW	DATE	28.12.2016			PROJECT NAME	GU-W4-SYSTEM OPEN
DRAWING BY	GULTEKIN YILMAZ					CONFIRMED BY	
CONTROLLED BY	ERDAL SAYAR					CONFIRMATION DATE	